

Dimension

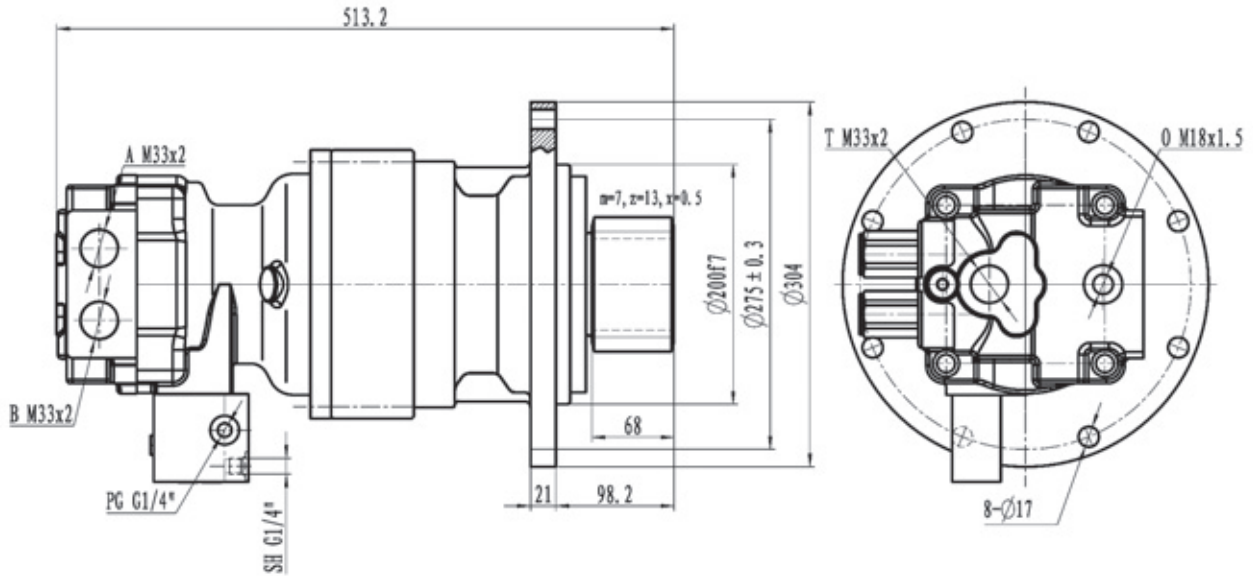

Technical Data

Output Torque (N · m)	Speed (r/min)	Ratio	Rated Pressure (MPa)	Displacement (ml/r)	Motor Displacement (ml/r)	Weight (Kg)	Excavator type (Ton)
2600	0-80	19.46	20	1028.87	52.871	70	7-8

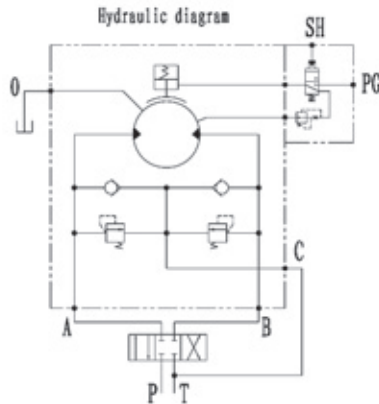

1. The neutral position of the control valve must be "0" type.
2. The oil boost port T of hydraulic motor should be connected with T port of control valve.
3. Maximum pressure of the brake is 5MPa.